



SERIES MCX 50Ω MICRO MINIATURE CONNECTORS

DESCRIPTION

HUBER+SUHNER MCX micro miniature snap-on connectors offer you an excellent blend of size, weight, durability and performance for applications such as mobile and fixed telecommunications, in GPS applications and in Test+Measurement systems for testing instruments and apparatus. They are designed for frequencies up to 6 GHz and are tested according to the international standard CECC 22220. And they meet all the high requirements that micro coaxial connectors are expected to satisfy today.

CONTENT

PAGE

Description	75
Interface Dimensions	75
Interface Dimensions in mm / inches	75
Technical Data	76
Cable Connectors	78
Receptacles with solder End	82
PCB Connectors	82

MCX

INTERFACE DIMENSIONS

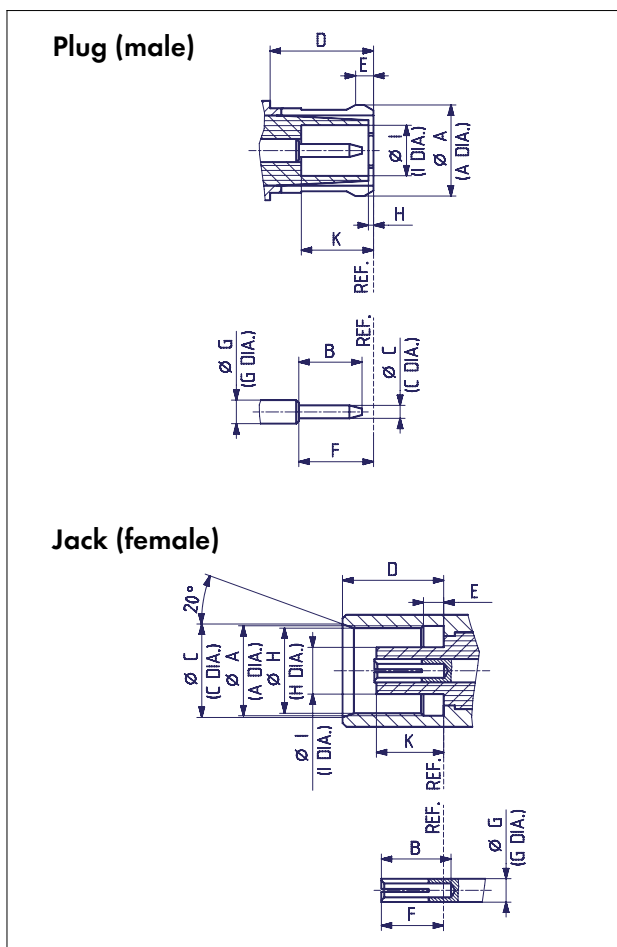

INTERFACE DIMENSIONS (MM / INCHES)

	Plug		Jack	
	min.	max.	min.	max.
A	3.72/.146*	3.80/.150*	3.60/.142	3.70/.146
B	2.49/.098	2.59/.102	2.80/.110	—
C	0.48/.019	0.53/.021	3.75/.148	3.85/.152
D	4.15/.163	—	4.00/.157	4.12/.162
E	0.70/.028	0.75/.030	0.75/.030	0.85/.033
F	2.80/.110	3.20/.126	2.30/.091	2.80/.110
G	0.95/.037 nom.		0.95/.037 nom.	
H	—	0.30/.012	3.42/.135	3.48/.137
I	2.00/.079	2.07/.081	1.80/.071	1.98/.078
K	2.80/.110	3.20/.126	2.60/.102	2.80/.110

* prior to slotting

Interface dimensions conformable to the Standards:

International: IEC 60169-36
Europe: CECC 22220

IP rating (interface, mated) IP50

TECHNICAL DATA

ELECTRICAL DATA	CECC 22000	TEST REQUIREMENTS
Impedance		50 Ω
Frequency range		DC ... 6 GHz
Dielectric withstanding voltage (at sea level)	4.4.5	≥ 750 V rms, 50 Hz (depending on cable)
Working voltage (at sea level) - unmated		≥ 170 V rms, 50 Hz (depending on cable)
Working voltage (at 21 000 m / 70 000 ft.) - unmated		≥ 42 V rms, 50 Hz (depending on cable)
Insulation resistance	4.4.4	≥ 10 ⁴ MΩ
Contact resistance - centre contact	4.4.2	≤ 5 mΩ
- outer contact	4.4.3	≤ 1 mΩ
RF leakage (measured at 1 GHz) - connectors for flexible cables - connectors for semi-rigid cables	4.4.8	≥ 60 dB ≥ 70 dB

MECHANICAL DATA	CECC 22000	REQUIREMENTS
Engagement force	4.5.1	≤ 25 N / 5.6 lbs
Disengagement force	4.5.1	8 N ... 20 N / 1.8 lbs ... 4.5 lbs
Contact captivation	4.5.2	≥ 10 N / 2.3 lbs
Cable retention force ¹⁾	4.5.5	see pages 28 - 34
Durability (matings)	4.7.1	≥ 500

1) Value considers maximum load of the cables without irreversible variations of specifications.

ENVIRONMENTAL DATA	CECC 22000	EQUIVALENT MIL TEST CONDITIONS
Temperature range		- 55° C ... + 155° C / - 67 °F ... + 311 °F
Climatic category		IEC → 55 / 155 / 21
Thermal shock	4.6.7	MIL-STD-202, Method 107, Condition F
High temperature endurance test	4.7.2	MIL-STD-202, Method 108A, Condition D
Moisture resistance	4.6.6	MIL-STD-202, Method 106
Corrosion	4.6.10	Saltspray test acc. to MIL-STD-202, Method 101, Condition B
Vibration	4.6.3	MIL-STD-202, Method 204, Condition D

MATERIAL DATA		
CONNECTOR PARTS	MATERIAL	PLATING
Pin contacts	brass	SUCOPRO / gold
Body	brass	SUCOPRO / SUCOPLATE [®] / gold
Socket contacts	copper-beryllium alloy	SUCOPRO/gold
Outer contacts - plug - jack	copper-beryllium alloy brass	SUCOPRO/gold / SUCOPLATE [®]
Crimp ferrules	copper / brass	SUCOPRO/gold
Insulators	PTFE or PFA	

Other materials and platings on request.

Some connectors may have a specification that differs from the above mentioned data.

The products are designed and guaranteed to pass the above mentioned test procedures. Any additional or different requirement arising from specific applications or environmental conditions which is not covered by these test procedures is subject to request.

CABLE CONNECTORS

Straight cable plugs (male)

> for semi-rigid cables, SUCOFORM and MULTIFLEX cables

- > cable entry soldered
- > centre contact soldered

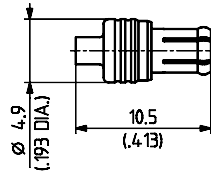

HUBER+SUHNER type	Item no.	Cable group (example)	Packaging	Assembly instruction
11_MCX-50-1-14/111_NE	23032081	Y2 (EZ 47)	single	27413
11_MCX-50-2-19/111_NH	23032147	Y3, Y11 (EZ 86)	bulk 100 pcs.	27496
11_MCX-50-3-1/111_NE	23024699	Y12 (Sucoform 141)	single	0000200108
11_MCX-50-3-1/111_NH	84006763	Y12 (Sucoform 141)	bulk 100 pcs.	0000200108

> for flexible cables

- > HUBER+SUHNER® full crimp
- > taper sleeves see page 406

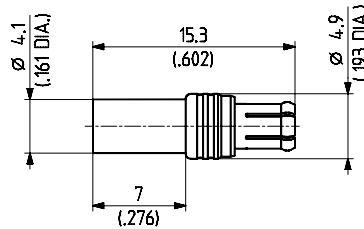

HUBER+SUHNER type	Item no.	Cable group (example)	Packaging	Assembly instruction	Crimp insert
11_MCX-50-1-13/133_NH	22658307	U1 (EF 178)	bulk 100 pcs.	27316	1 A
11_MCX-50-1-13/111_NH	23002830	U1 (EF 178)	bulk 100 pcs.	27316	1 A
11_MCX-50-2-15/111_NE	84018641	U4 (EF 316 D)	single	27306	1 A
11_MCX-50-2-15/111_NH	23000440	U4 (EF 316 D)	bulk 100 pcs.	27306	1 A
11_MCX-50-2-15/133_NH	23000566	U4 (EF 316 D)	bulk 100 pcs.	27306	1 A
11_MCX-50-2-16/111_NE	84022831	U2 (EF 316)	single	27306	1 A
11_MCX-50-2-16/111_NH	22658275	U2 (EF 316)	bulk 100 pcs.	27306	1 A
11_MCX-50-2-16/133_NH	23000437	U2 (EF 316)	bulk 100 pcs.	27306	1 A

Right angle cable plugs (male)

> for semi-rigid cables, SUCOFORM and MULTIFLEX cables

- > cable entry soldered
- > centre contact soldered

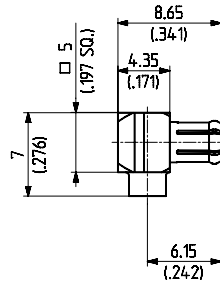

HUBER+SUHNER type	Item no.	Cable group (example)	Packaging	Assembly instruction
16_MCX-50-1-11/111_NE	23024700	Y2 (EZ 47)	single	27495
16_MCX-50-1-11/111_NH	23032063	Y2 (EZ 47)	bulk 100 pcs.	27495
16_MCX-50-2-104/111_NH	23032067	Y3, Y11 (EZ 86)	bulk 100 pcs.	27308
16_MCX-50-3-8/111_NH	23012471	Y5, Y12 (EZ 141)	bulk 100 pcs.	27401

> for flexible cables

- > cable entry crimp
- > centre contact soldered
- > taper sleeves see page 406

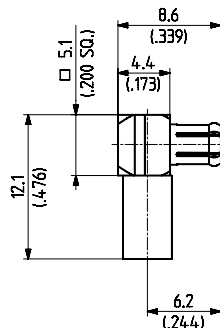

HUBER+SUHNER type	Item no.	Cable group (example)	Packaging	Assembly instruction	Crimp insert
16_MCX-50-1-7/111_NH	23000443	U1 (EF 178)	bulk 100 pcs.	27319	A
16_MCX-50-1-7/133_NH	22658308	U1 (EF 178)	bulk 100 pcs.	27319	A
16_MCX-50-2-11/133_NE	22660003	U4 (EF 316 D)	single	27102	A
16_MCX-50-2-11/133_NH	22650803	U4 (EF 316 D)	bulk 100 pcs.	27102	A
16_MCX-50-2-11/111_NH	23015358	U4 (EF 316 D)	bulk 100 pcs.	27102	A
16_MCX-50-2-14/133_NE	22660002	U2 (EF 316)	single	27102	A
16_MCX-50-2-14/133_NH	22660001	U2 (EF 316)	bulk 100 pcs.	27102	A
16_MCX-50-2-14/111_NH	23000445	U2 (EF 316)	bulk 100 pcs.	27102	A

- > for flexible cables
- > low profile
- > cable entry soldered
- > centre contact soldered

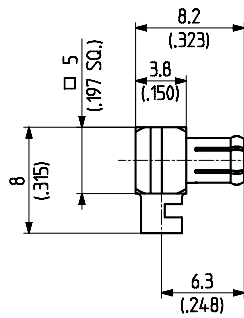

HUBER+SUHNER type	Item no.	Cable group (example)	Packaging	Assembly instruction
16_MCX-50-2-102/111_NH	23000454	U2 (EF 316)	bulk 100 pcs.	27307

Straight cable jacks (female)

- > for flexible cables
- > HUBER+SUHNER® full crimp
- > taper sleeves see page 406

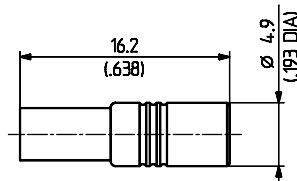

HUBER+SUHNER type	Item no.	Cable group (example)	Packaging	Assembly instruction	Crimp insert
21_MCX-50-1-11/111_NE	84023972	U1 (EF 178)	single	27317	1 A
21_MCX-50-1-11/111_NH	23005297	U1 (EF 178)	bulk 100 pcs.	27317	1 A
21_MCX-50-2-12/111_NE	23032052	U4 (EF 316 D)	single	27309	1 A
21_MCX-50-2-12/133_NH	22658278	U4 (EF 316 D)	bulk 100 pcs.	27309	1 A
21_MCX-50-2-13/111_NH	23005298	U2 (EF 316)	bulk 100 pcs.	27309	1 A
21_MCX-50-2-13/133_NH	22658279	U2 (EF 316)	bulk 100 pcs.	27309	1 A

Straight bulkhead cable jacks (female)

> for semi-rigid cables, SUCOFORM and MULTIFLEX cables

- > cable entry soldered
- > centre contact soldered

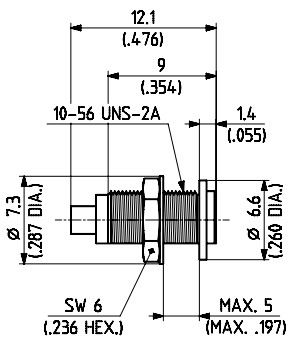

Fig. 1

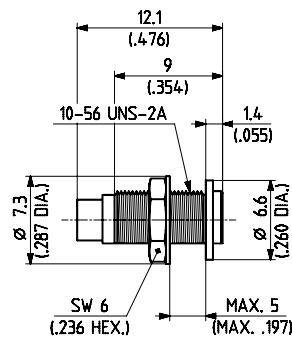

Fig. 2



MCX 50

HUBER+SUHNER type	Item no.	Cable group (example)	Packaging	Assembly instruction/ Mounting hole	Fig.
24_MCX-50-1-3/111_NE	22641648	Y2 (EZ 47)	single	3100 / ML 11	1
24_MCX-50-2-3/111_NE	22543580	Y3, Y11 (EZ 86)	single	3100 / ML 11	2

☒ centre contact NOT captivated

> for flexible cables

- > HUBER+SUHNER® full crimp
- > taper sleeves see page 406

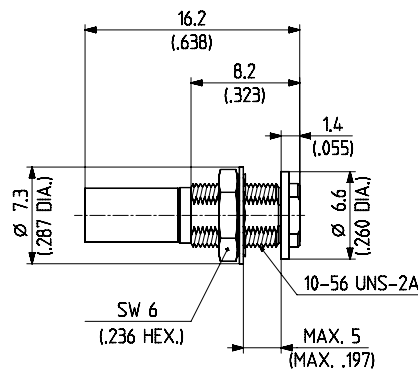

HUBER+SUHNER type	Item no.	Cable group (example)	Packaging	Assembly instruction/ Mounting hole	Crimp insert
24_MCX-50-1-13/111_NH	23005299	U1 (EF 178)	bulk 100 pcs.	27317 / ML 11	1 A
24_MCX-50-1-13/133_NH	22658310	U1 (EF 178)	bulk 100 pcs.	27317 / ML 11	1 A
24_MCX-50-2-6/111_NH	23005300	U4 (EF 316 D)	bulk 100 pcs.	27309 / ML 11	1 A
24_MCX-50-2-7/111_NH	23000468	U2 (EF 316)	bulk 100 pcs.	27309 / ML 11	1 A

RECEPTACLES WITH SOLDER END

Receptacles, jacks (female)

- > bulkhead mounted
- > front mounting

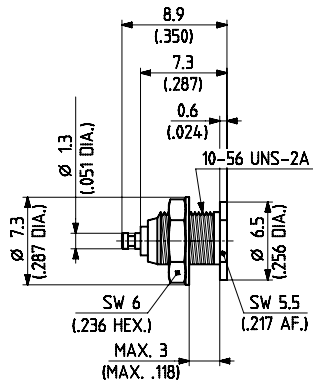

Fig. 1

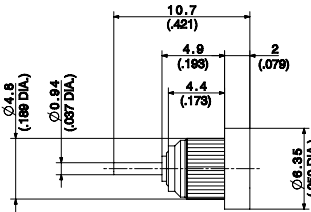

Fig. 2 (press-in)



HUBER+SUHNER type	Item no.	Packaging	Mounting hole	Fig.
22_MCX-50-0-2/111_NE	22640171	single	ML 11	1
22_MCX-50-0-2/111_NH	22646960	bulk 100 pcs.	ML 11	1
22_MCX-50-0-2/133_NE	22643633	single	ML 11	1
22_MCX-50-0-2/133_NH	22644433	bulk 100 pcs.	ML 11	1
22_MCX-50-0-19/111_NH	22652984	bulk 100 pcs.	ML 103	2
22_MCX-50-0-19/133_NH	23019789	bulk 100 pcs.	ML 103	2

PCB CONNECTORS

Straight PCB plugs (male)

- > with stand-off
- > 2.54 mm / .100 in. grid

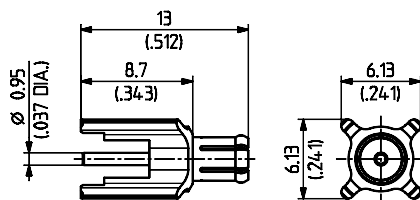

Fig. 1

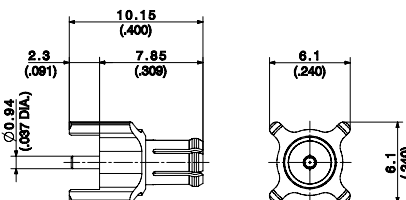

Fig. 2



HUBER+SUHNER type	Item no.	Packaging	Mounting hole	Fig.
81_MCX-50-0-6/111_NE	84023713	single	ML 15	1
81_MCX-50-0-6/111_NH	23005296	bulk 100 pcs.	ML 15	1
81_MCX-50-0-9/111_NH	23026871	bulk 100 pcs.	ML 15	2

Straight PCB jacks (female)

> 2.54 mm / .100 in. grid

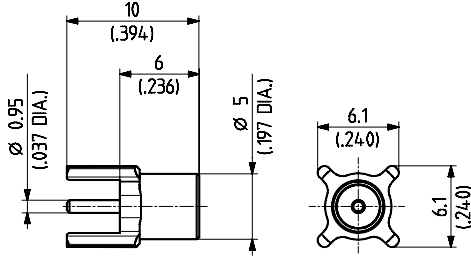

Fig. 1

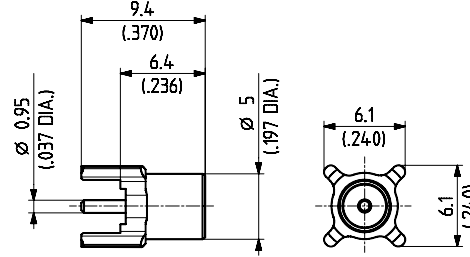
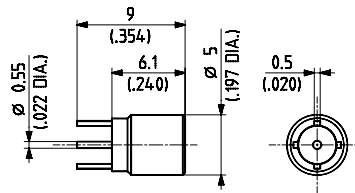

Fig. 2

HUBER+SUHNER type	Item no.	Packaging	Mounting hole	Notes	Fig.
82_MCX-50-0-17/111_NH	23006209	bulk 100 pcs.	ML 15	without stand-off	1
82_MCX-50-0-19/111_NE	84018352	single	ML 15	with stand-off	2
82_MCX-50-0-19/111_NH	22658305	bulk 100 pcs.	ML 15	with stand-off	2
82_MCX-50-0-19/111_NM	23000573	tape and reel	ML 15	with stand-off	2

> 1.27 mm / .05 in. grid

> space saving version



HUBER+SUHNER type	Item no.	Packaging	Mounting hole	Notes
82_MCX-50-0-10/111_NE	22641649	single	ML 44	without stand-off
82_MCX-50-0-10/111_NH	22651980	bulk 100 pcs.	ML 44	without stand-off

> surface mount type SMT

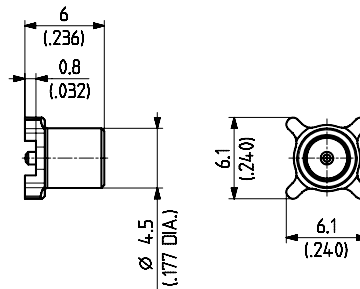

HUBER+SUHNER type	Item no.	Packaging	Mounting hole	Notes
82_MCX-50-0-29/111_NE	84018482	single	ML 120	
82_MCX-50-0-29/111_NH	23001527	bulk 100 pcs.	ML 120	
82_MCX-50-0-29/111_NM	22658306	tape and reel	ML 120	

- > surface mount type SMT
- > edge mount

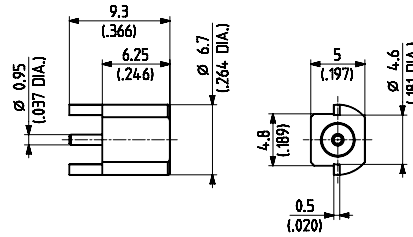

HUBER+SUHNER type	Item no.	Packaging	Mounting hole	Notes
82_MCX-S50-0-22/111_NE	22651467	single	ML 121	
82_MCX-S50-0-22/111_NM	84011207	tape and reel	ML 121	

Right angle PCB jacks (female)

- > 2.54 mm / .100 in. grid

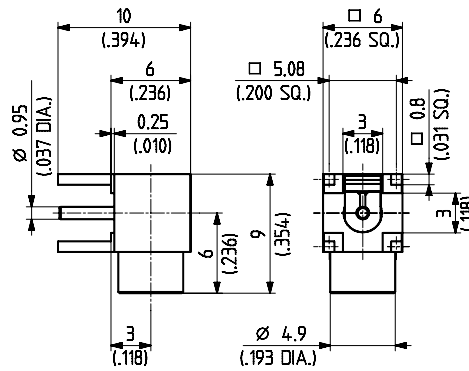

HUBER+SUHNER type	Item no.	Packaging	Mounting hole	Notes
85_MCX-50-0-16/111_NE	84018523	single	ML 15	
85_MCX-50-0-16/111_NH	23001545	bulk 100 pcs.	ML 15	
85_MCX-50-0-16/111_NM	84030779	tape and reel	ML 15	

- > surface mount type SMT

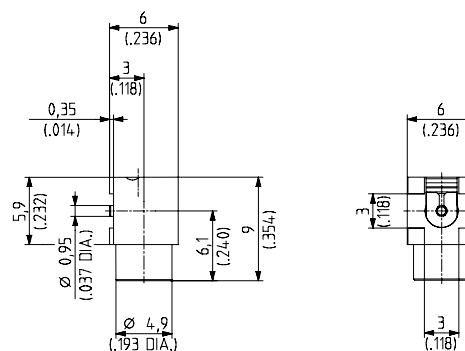

HUBER+SUHNER type	Item no.	Packaging	Mounting hole	Notes
85_MCX-S50-0-25/111_NH	23005091	bulk 100 pcs.	ML 123	
85_MCX-S50-0-25/111_NM	84036471	tape and reel	ML 123	